



Natural Gas Inline Bypass Ball Valve Procedure

NOTE: Failure to follow this procedure may result in interrupted gas service and loss of pilot lights.
Ensure all users have proper training with bypass valves before operating.

NOTE: It is recommended to monitor downstream pressure before, during, and after bypass operation to ensure gas flow is continuous. In the event the pressure drops below your stated system requirements, an improper sequence may have occurred. The valves should be returned to normal operation immediately to restore flow of gas. Once pressure is restored, the bypass procedure can then be started again. If the pressure drops below your stated system requirements at any time, pilots need to be checked and possibly relit.

- Apply thread sealant to NPT threads where applicable. Do not use PTFE tape.
- Follow all applicable codes and procedures.

Shutoff plug should operate smoothly, **STOP OPENING IMMEDIATELY WHEN RESISTANCE IS FELT.**

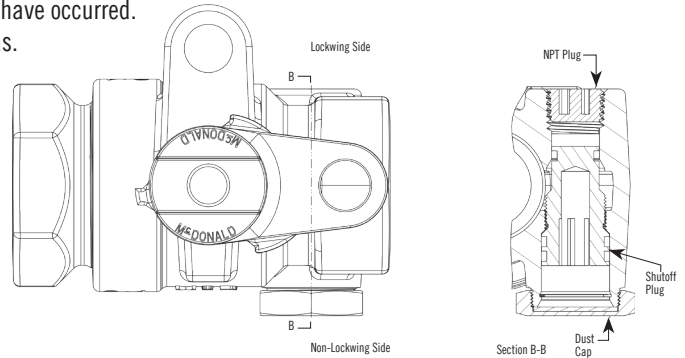

STEP 1	<p>Remove the dust cap on the non-lockwing side of the inlet inline bypass ball valve.</p>	STEP 2	<p>Ensure the shutoff plug on non-lockwing side of inlet inline bypass ball valve is threaded in all the way. If the shutoff plug is not threaded all the way in, do so before proceeding.</p>
STEP 3	<p>Remove the NPT plug on the lockwing side of the inlet inline bypass ball valve.</p>	STEP 4	<p>Thread the high pressure side of the regulating hose kit into lockwing side of the inlet inline bypass ball valve and loosely thread the other end of the regulating hose kit to the outlet valve.</p>
STEP 5	<p>Thread the shutoff plug on the non-lockwing side of the inlet inline bypass ball valve counter-clockwise out to the snap-ring stop to purge the regulating hose kit. This will require approximately 7-9 turns. Stop opening immediately when resistance is felt.</p>	STEP 6	<p>Tighten the regulating hose kit connection to the outlet valve once the regulating hose kit is purged.</p>
STEP 7	<p>Fully close the outlet valve.</p>	STEP 8	<p>Fully close the inlet inline bypass ball valve.</p>

Over →

Inline Bypass Ball Valve Procedure

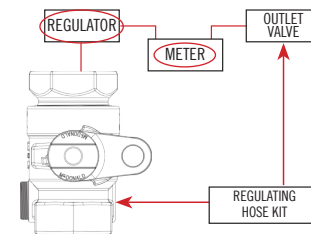
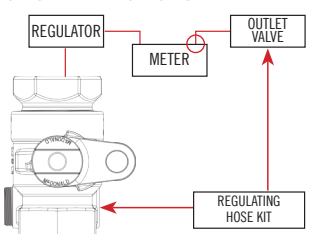
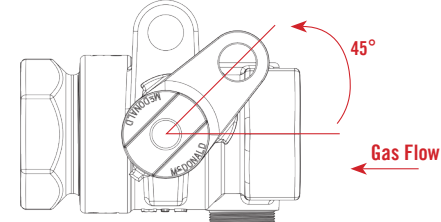
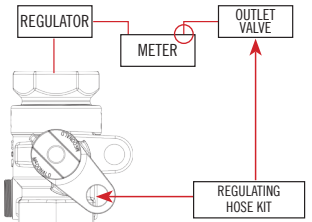
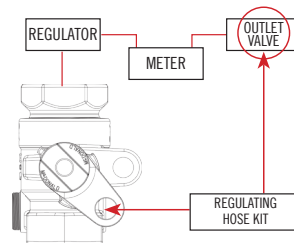
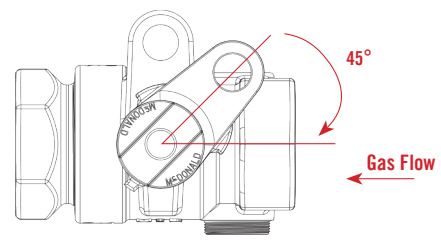
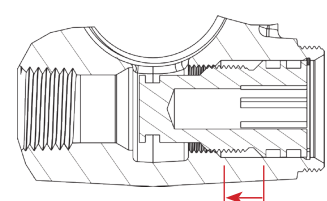
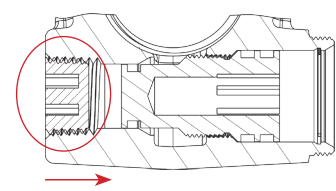
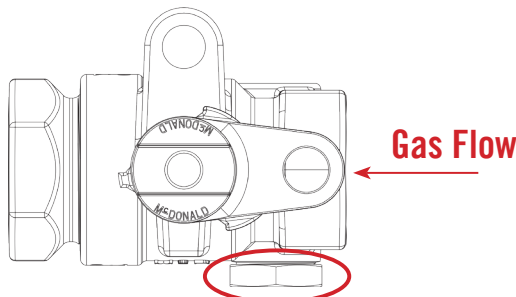
<p>STEP 9</p> <p>The meter and regulator are now isolated for change-out and/or maintenance.</p> 	<p>STEP 10</p> <p>Once ready to transition back to normal flow mode leave the outlet meter nut loose (or open purge plug) to allow purging of the meter.</p> 
<p>STEP 11</p> <p>Turn the inlet inline bypass ball valve to the half-open position (valve at half-open (45°) position).</p> 	<p>STEP 12</p> <p>Once the meter has been purged, tighten the outlet meter nut (or purge plug).</p> 
<p>STEP 13</p> <p>Fully open the outlet valve.</p> 	<p>STEP 14</p> <p>Fully open the inlet inline bypass ball valve.</p> 
<p>STEP 15</p> <p>Thread the shutoff plug on the non-lockwing side of the inlet inline bypass ball valve in until the stop. This will require approximately 7-9 turns. Plug may require some force to close against gas pressure.</p> 	<p>STEP 16</p> <p>Remove the regulating hose kit from both the inlet inline bypass ball valve and the outlet valve and re-install the NPT plugs, pipe dope not required.</p> 
<p>STEP 17</p> <p>Hand thread the dust cap on the non-lockwing side of the inlet inline bypass ball valve.</p> 	

Inline bypass valves are operated by a proprietary pentagon key supplied by A.Y. McDonald.